

PANEL 31

UNLESS OTHERWISE SPECIFIED: DIMENSIONS ARE IN MILLIMETERS			FINISH: MR. ABHI GHUPTA		DEBURR AND BREAK SHARP EDGES		DO NOT SCALE DRAWING		REVISION		
SURFACE FINISH:											
TOLERANCES:											
LINEAR:											
ANGULAR:											
DRAWN		NAME		SIGNATURE		DATE		TITLE:			
CHK'D		ABHISHEK PAL									
APPV'D		BIREN NAYAK									
MFG		ANUJ RAHEJA									
Q.A											
						MATERIAL:		DWG NO.		31	
								AB_AJMER_PANEL_DWG		31 to	
						WEIGHT:		SCALE:1:10		SHEET 1 OF 17	

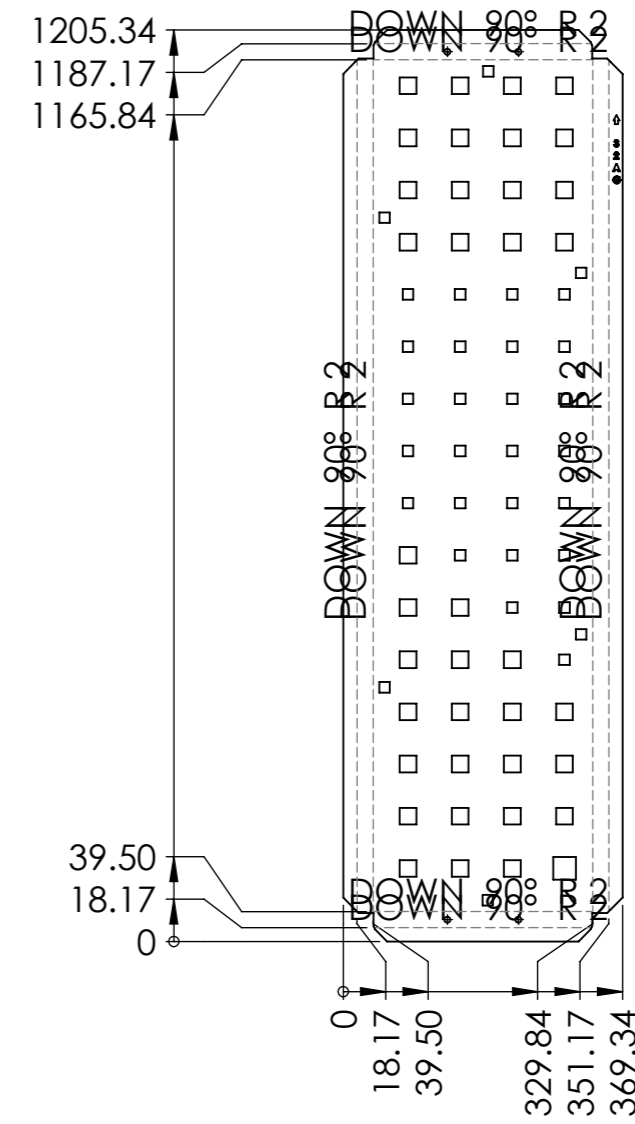
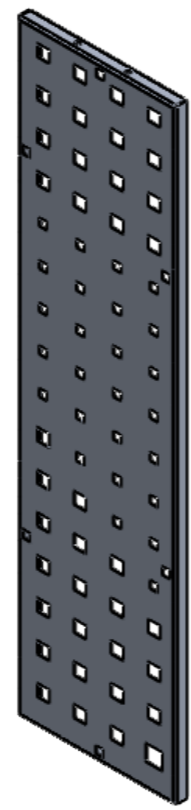
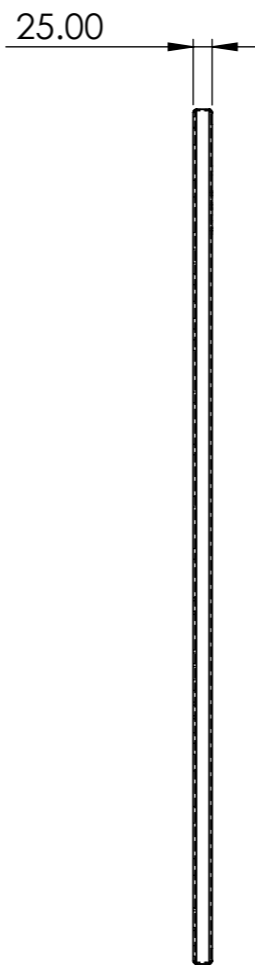
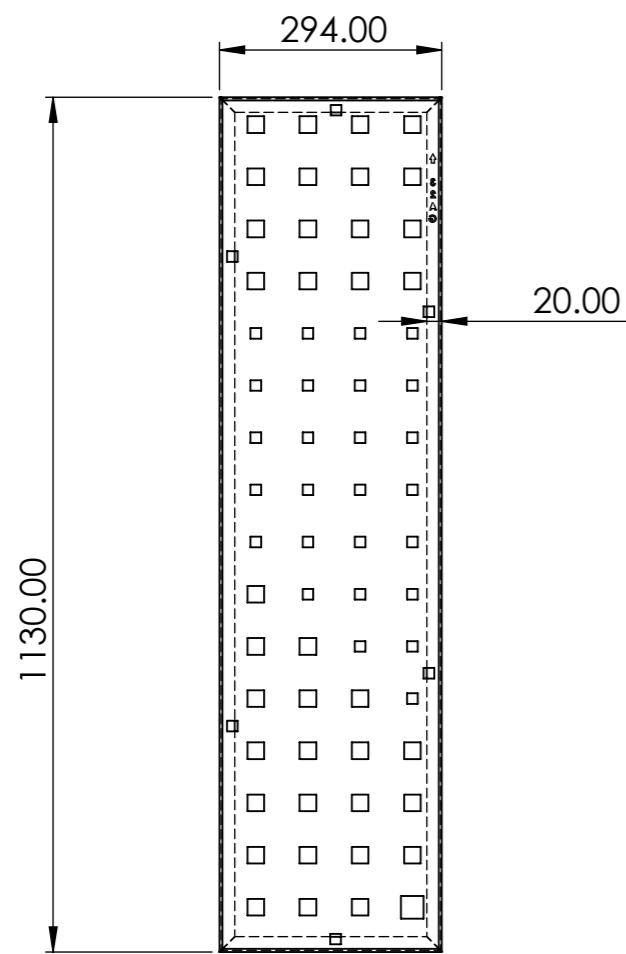

PANEL 32

UNLESS OTHERWISE SPECIFIED: DIMENSIONS ARE IN MILLIMETERS SURFACE FINISH: TOLERANCES: LINEAR: ANGULAR:		FINISH: MR. ABHI GHUPTA		DEBURR AND BREAK SHARP EDGES		DO NOT SCALE DRAWING		REVISION	
DRAWN ABHISHEK PAL		SIGNATURE		DATE		TITLE:			
CHK'D BIREN NAYAK									
APPV'D ANUJ RAHEJA									
MFG									
Q.A						MATERIAL:		DWG NO.	
						WEIGHT:		SCALE:1:10	
								SHEET 2 OF 17	

AB_AJMER_PANEL_DWG 31 to 43

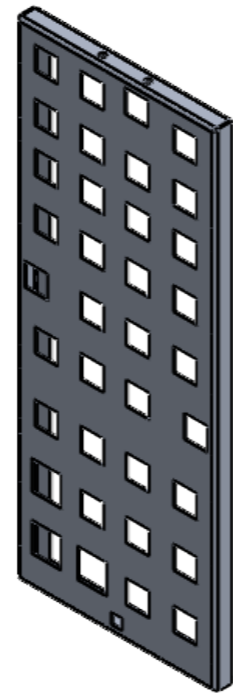
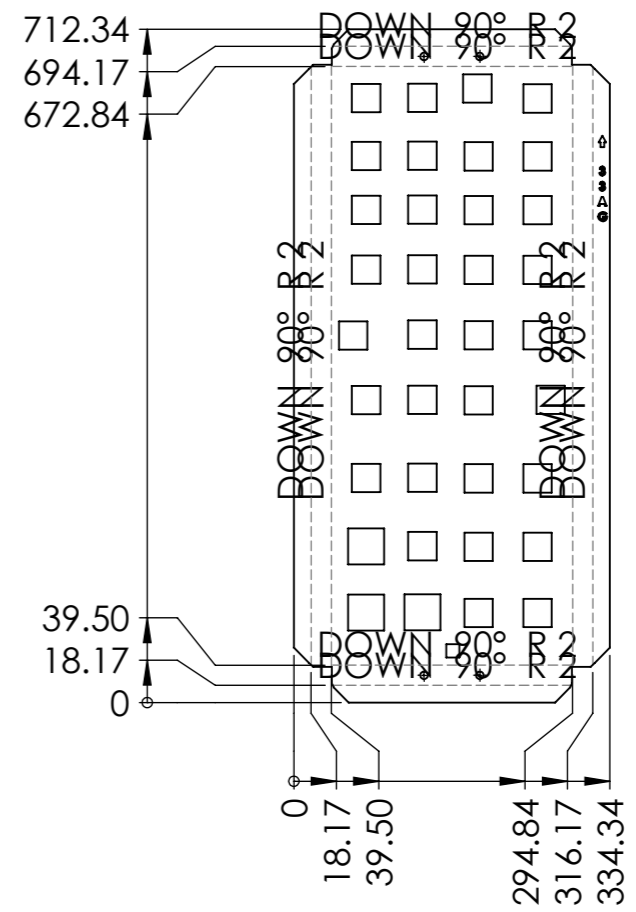
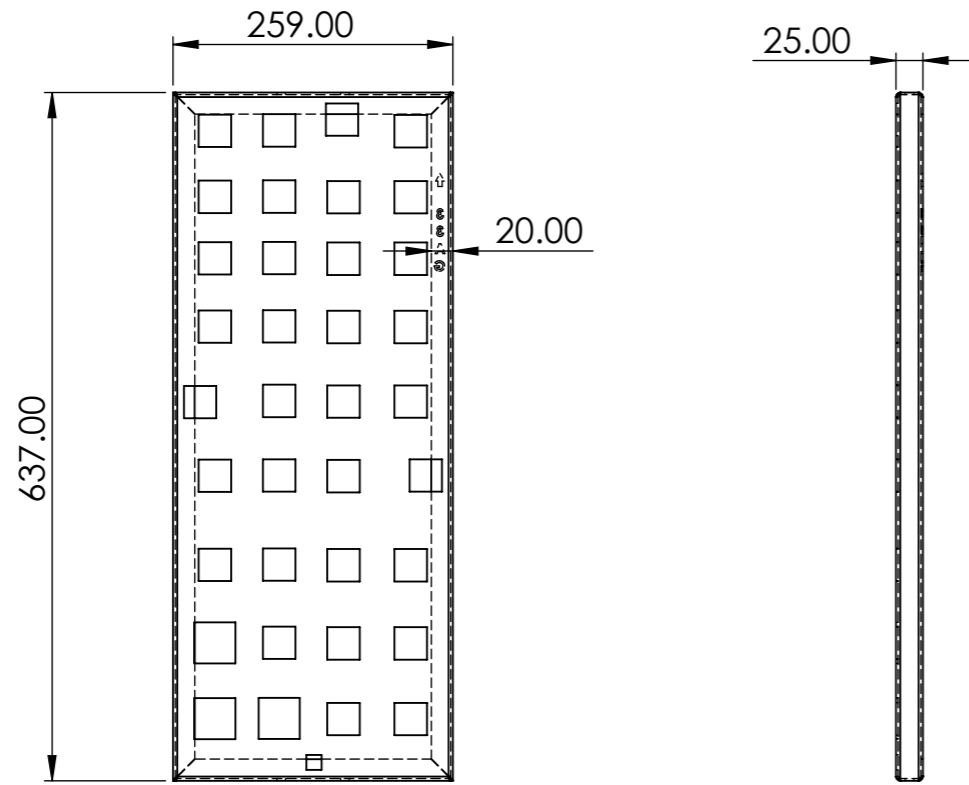

PANEL 33

UNLESS OTHERWISE SPECIFIED: DIMENSIONS ARE IN MILLIMETERS SURFACE FINISH: TOLERANCES: LINEAR: ANGULAR:		FINISH: MR. ABHI GHUPTA		DEBURR AND BREAK SHARP EDGES		DO NOT SCALE DRAWING		REVISION	
DRAWN ABHISHEK PAL		SIGNATURE		DATE		TITLE:			
CHK'D BIREN NAYAK									
APPV'D ANUJ RAHEJA									
MFG									
Q.A						MATERIAL:		DWG NO.	
						WEIGHT:		SCALE:1:13	
								SHEET 3 OF 17	

AB_AJMER_PANEL_DWG 31 to 43

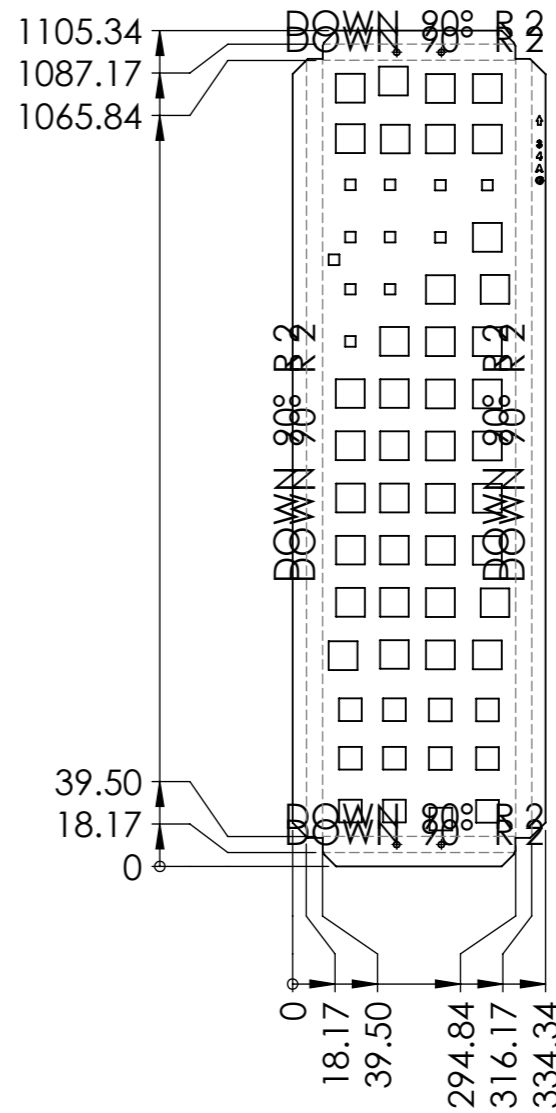
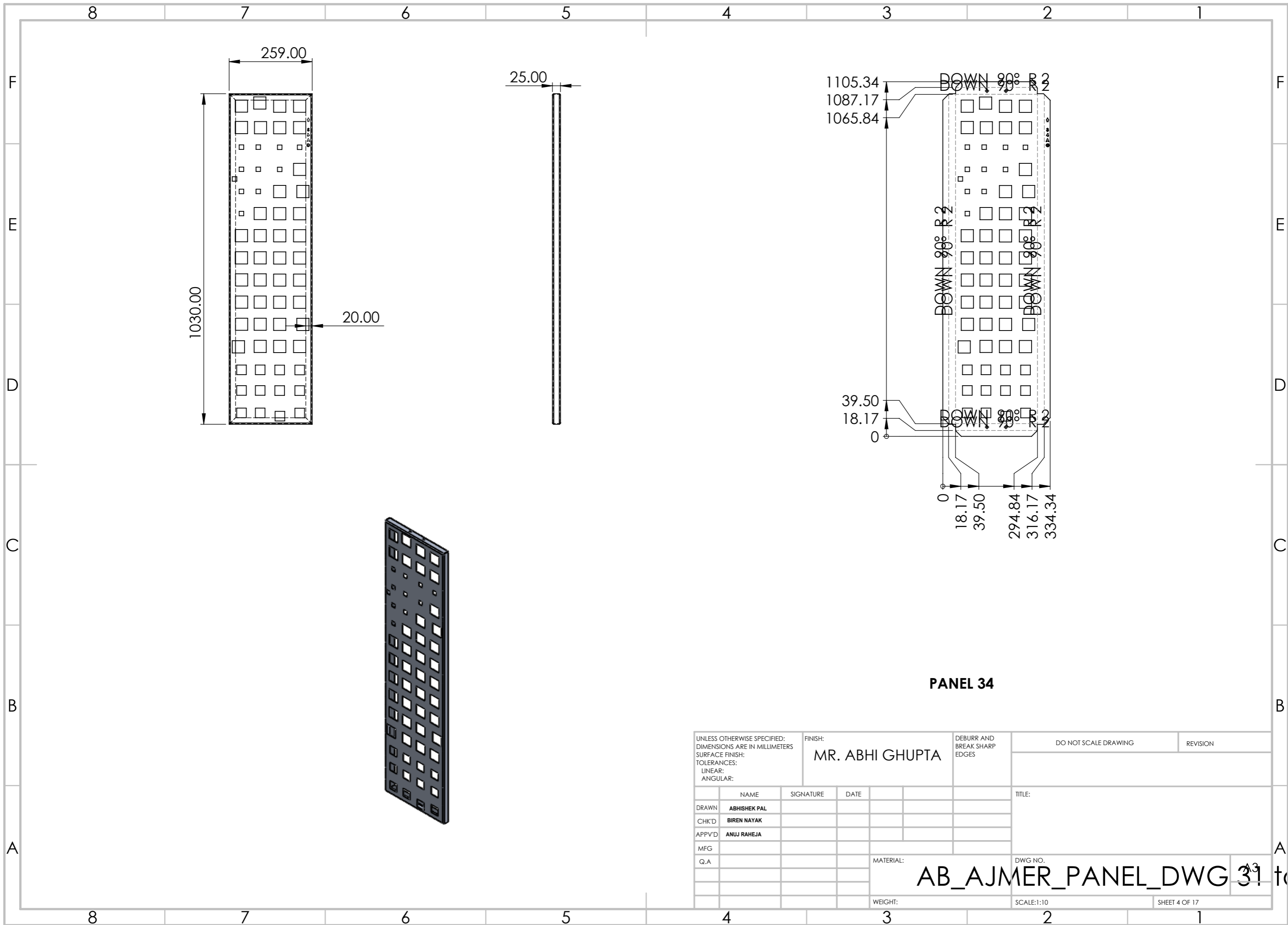

PANEL 34

UNLESS OTHERWISE SPECIFIED: DIMENSIONS ARE IN MILLIMETERS SURFACE FINISH: TOLERANCES: LINEAR: ANGULAR:		FINISH: MR. ABHI GHUPTA		DEBURR AND BREAK SHARP EDGES		DO NOT SCALE DRAWING		REVISION	
DRAWN ABHISHEK PAL		SIGNATURE		DATE		TITLE:			
CHK'D BIREN NAYAK									
APPV'D ANUJ RAHEJA									
MFG									
Q.A						MATERIAL:		DWG NO. 31 to 43	
						WEIGHT:		SCALE:1:10	
								SHEET 4 OF 17	

AB_AJMER_PANEL_DWG 31 to 43

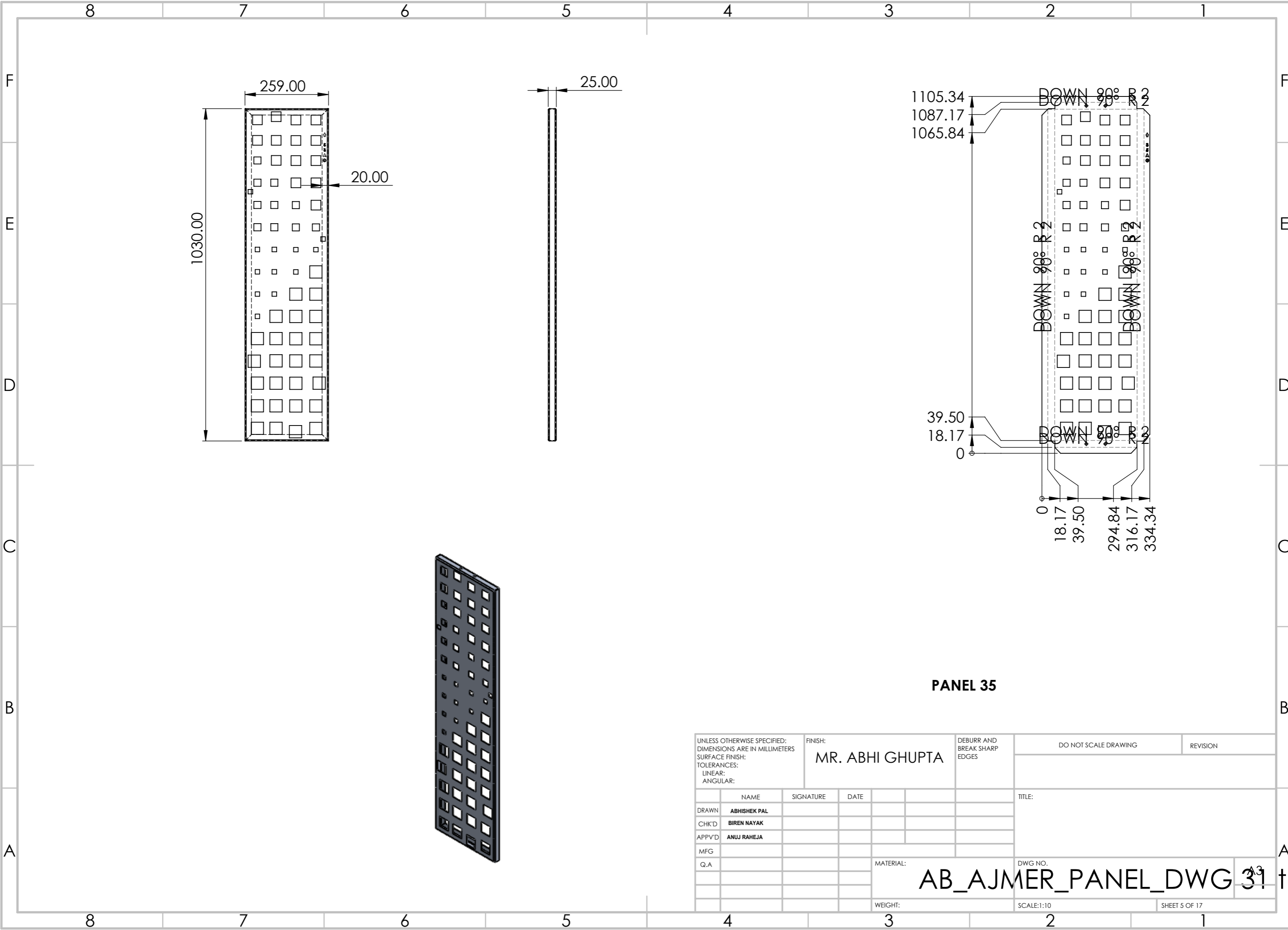

PANEL 35

UNLESS OTHERWISE SPECIFIED: DIMENSIONS ARE IN MILLIMETERS		FINISH: MR. ABHI GHUPTA		DEBURR AND BREAK SHARP EDGES		DO NOT SCALE DRAWING		REVISION	
SURFACE FINISH:									
TOLERANCES:									
LINEAR:									
ANGULAR:									
DRAWN ABHISHEK PAL		SIGNATURE		DATE		TITLE:			
CHK'D BIREN NAYAK									
APPV'D ANUJ RAHEJA									
MFG									
Q.A						MATERIAL:		DWG NO.	
								AB_AJMER_PANEL_DWG 31 to 33	
						WEIGHT:		SCALE:1:10	
								SHEET 5 OF 17	

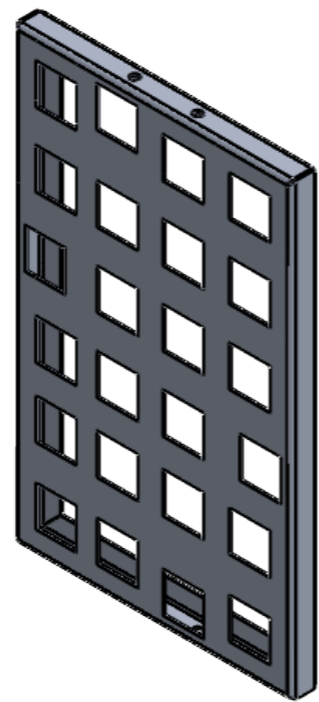
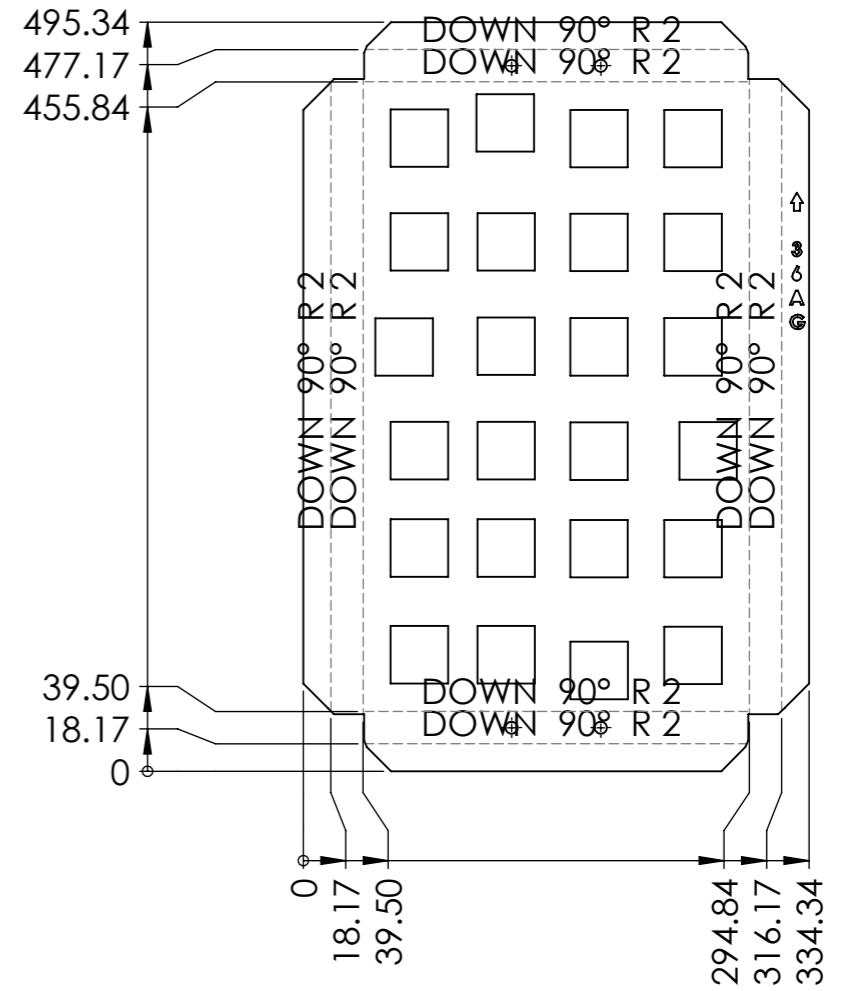
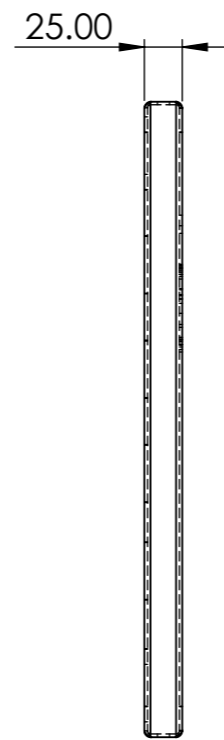
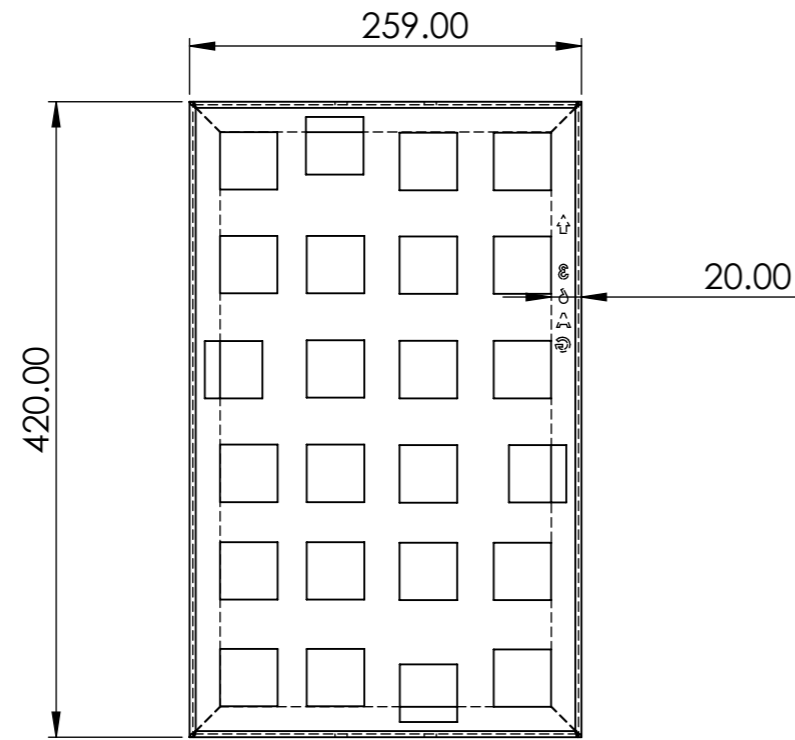

PANEL 36

UNLESS OTHERWISE SPECIFIED: DIMENSIONS ARE IN MILLIMETERS SURFACE FINISH: TOLERANCES: LINEAR: ANGULAR:		FINISH: MR. ABHI GHUPTA		DEBURR AND BREAK SHARP EDGES		DO NOT SCALE DRAWING		REVISION	
DRAWN ABHISHEK PAL		SIGNATURE		DATE		TITLE:			
CHK'D BIREN NAYAK									
APPV'D ANUJ RAHEJA									
MFG						MATERIAL:		DWG NO.	
Q.A								31 to	
						WEIGHT:		SCALE:1:5	
								SHEET 6 OF 17	

AB_AJMER_PANEL_DWG 31 to

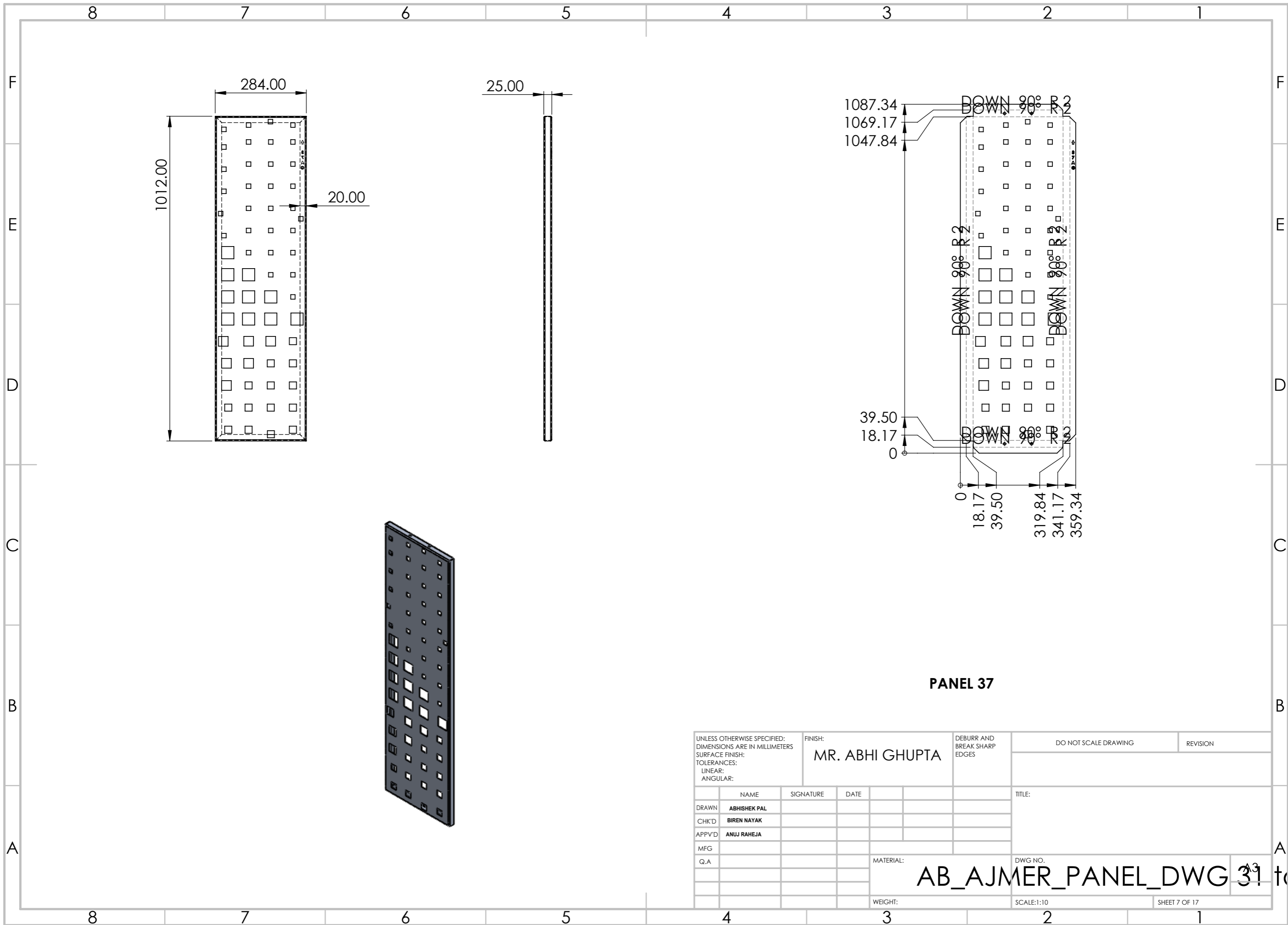

PANEL 37

UNLESS OTHERWISE SPECIFIED: DIMENSIONS ARE IN MILLIMETERS SURFACE FINISH: TOLERANCES: LINEAR: ANGULAR:			FINISH: MR. ABHI GHUPTA		DEBURR AND BREAK SHARP EDGES		DO NOT SCALE DRAWING		REVISION	
DRAWN ABHISHEK PAL			SIGNATURE		DATE		TITLE:			
CHK'D BIREN NAYAK										
APPV'D ANUJ RAHEJA										
MFG										
Q.A							MATERIAL:		DWG NO.	
							WEIGHT:		SCALE:1:10	
									SHEET 7 OF 17	

AB_AJMER_PANEL_DWG 31 to 43

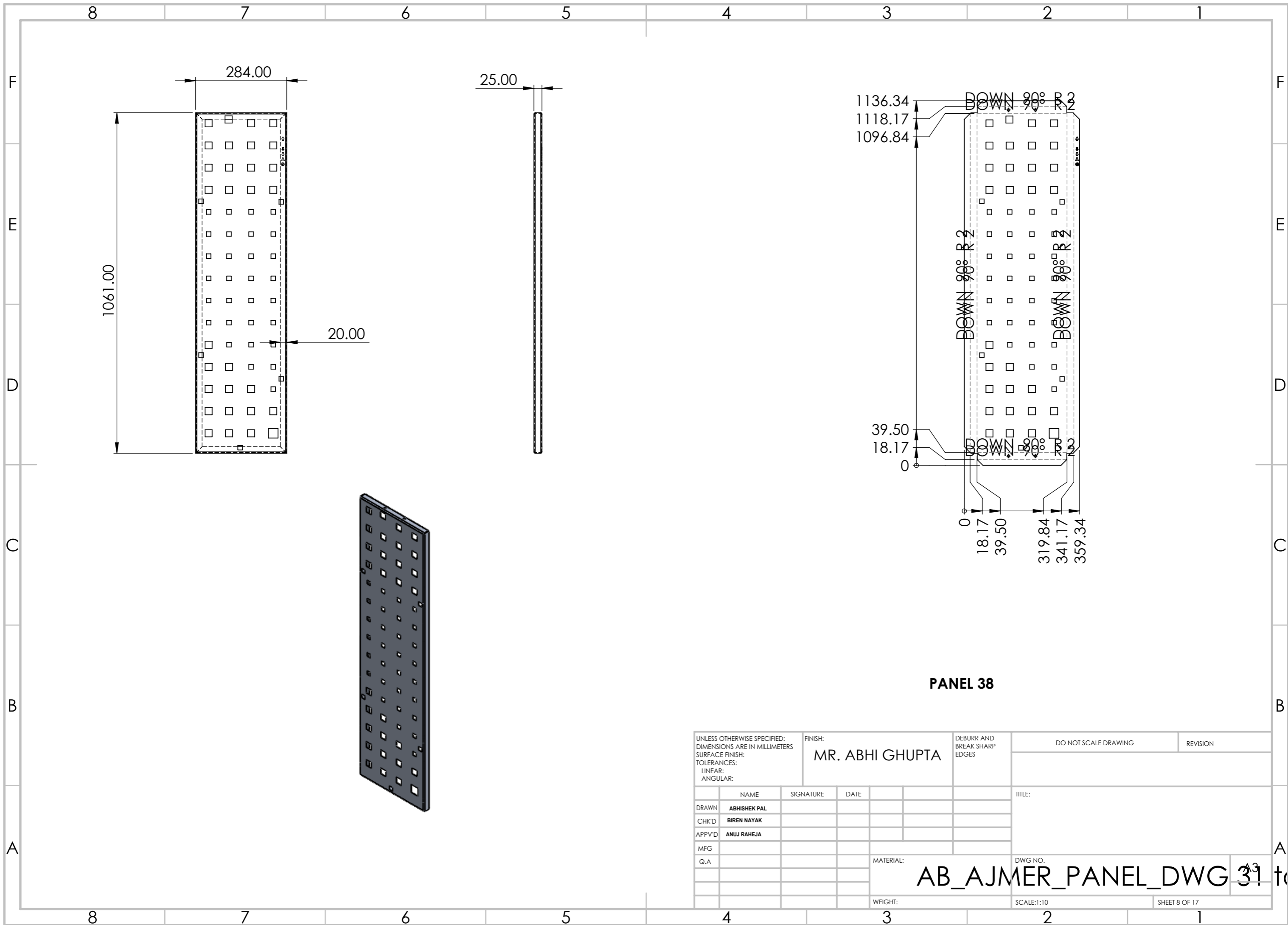

PANEL 38

UNLESS OTHERWISE SPECIFIED: DIMENSIONS ARE IN MILLIMETERS		FINISH: MR. ABHI GHUPTA		DEBURR AND BREAK SHARP EDGES		DO NOT SCALE DRAWING		REVISION	
SURFACE FINISH:									
TOLERANCES:									
LINEAR:									
ANGULAR:									
DRAWN		NAME	SIGNATURE	DATE			TITLE:		
CHK'D		ABHISHEK PAL					AB_AJMER_PANEL_DWG 31 to		
APPV'D		BIREN NAYAK					DWG NO.		
MFG		ANUJ RAHEJA					43		
Q.A					MATERIAL:		SCALE:1:10		
					WEIGHT:		SHEET 8 OF 17		

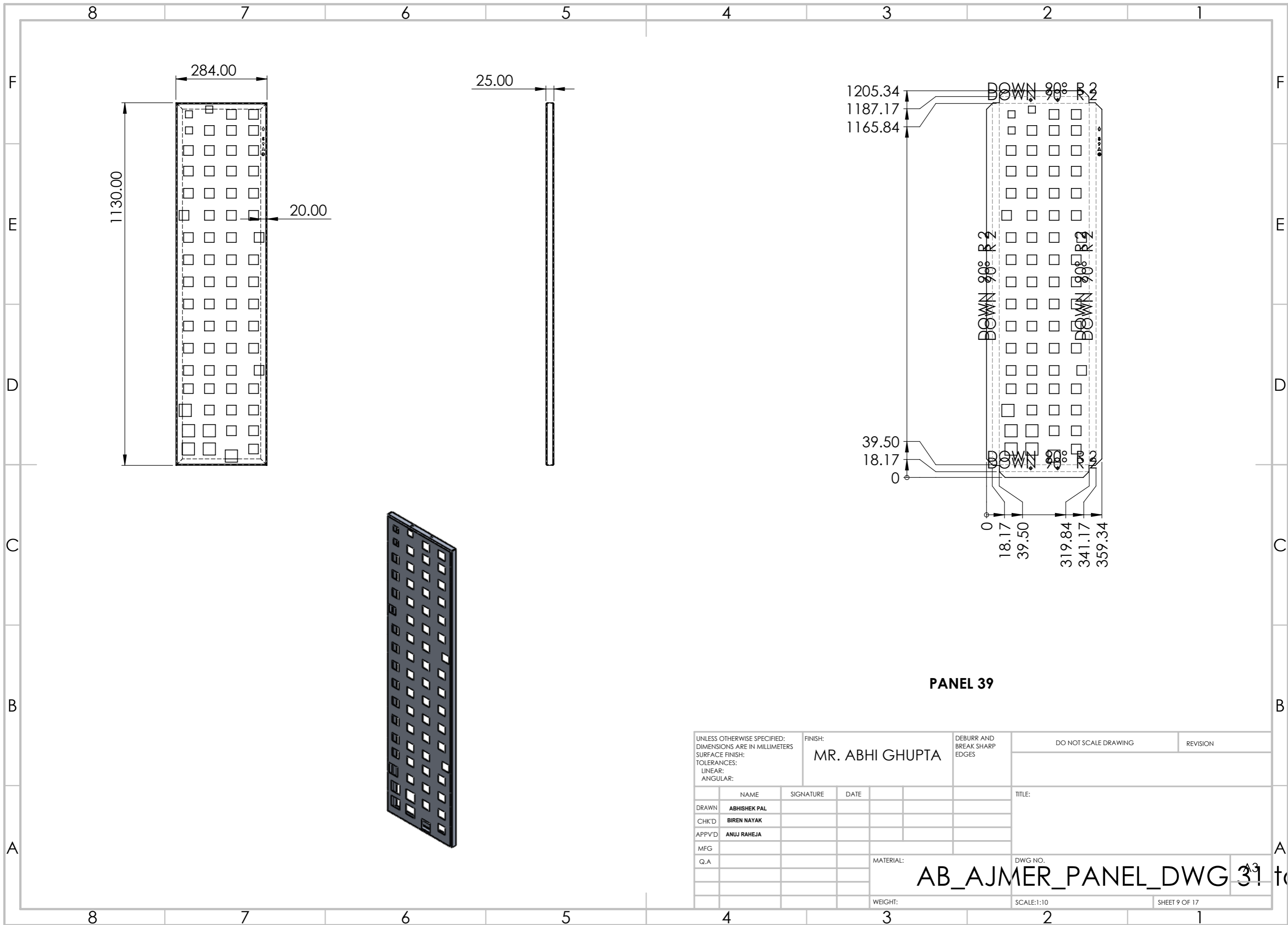

PANEL 39

UNLESS OTHERWISE SPECIFIED: DIMENSIONS ARE IN MILLIMETERS SURFACE FINISH: TOLERANCES: LINEAR: ANGULAR:			FINISH: MR. ABHI GHUPTA		DEBURR AND BREAK SHARP EDGES	DO NOT SCALE DRAWING	REVISION
DRAWN	ABHISHEK PAL	SIGNATURE	DATE			TITLE:	
CHK'D	BIREN NAYAK						
APPV'D	ANUJ RAHEJA						
MFG							
Q.A					MATERIAL:	DWG NO.	
						AB_AJMER_PANEL_DWG 31 to	43
					WEIGHT:	SCALE:1:10	SHEET 9 OF 17

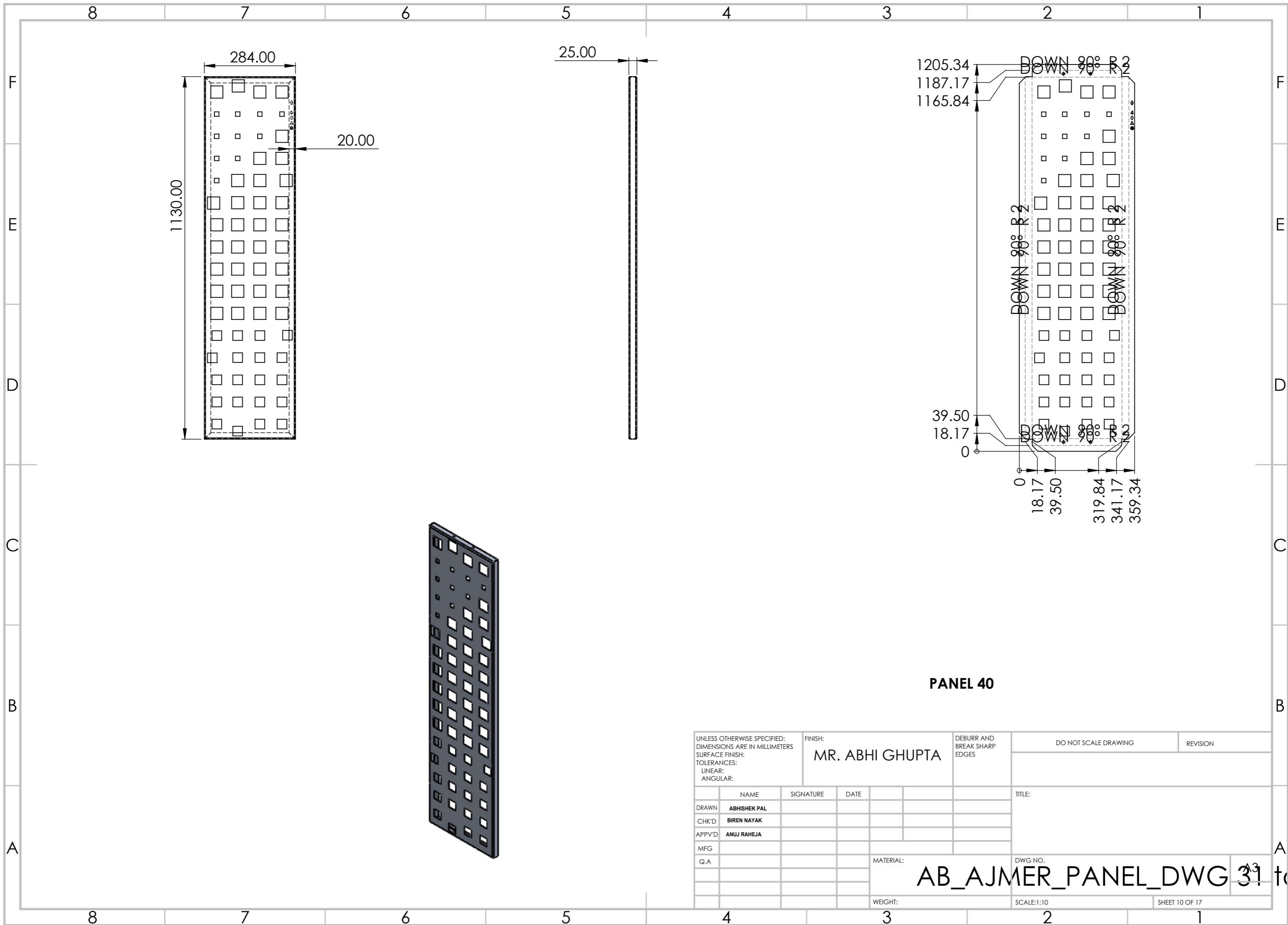

PANEL 40

UNLESS OTHERWISE SPECIFIED: DIMENSIONS ARE IN MILLIMETERS SURFACE FINISH: TOLERANCES: LINEAR: ANGULAR:		FINISH: MR. ABHI GHUPTA		DEBURR AND BREAK SHARP EDGES		DO NOT SCALE DRAWING		REVISION	
DRAWN ABHISHEK PAL		SIGNATURE		DATE		TITLE:			
CHK'D BIREN NAYAK									
APPV'D ANUJ RAHEJA									
MFG									
Q.A						MATERIAL:		DWG NO. 43	
						WEIGHT:		SCALE:1:10	
								SHEET 10 OF 17	

AB_AJMER_PANEL_DWG 31 to

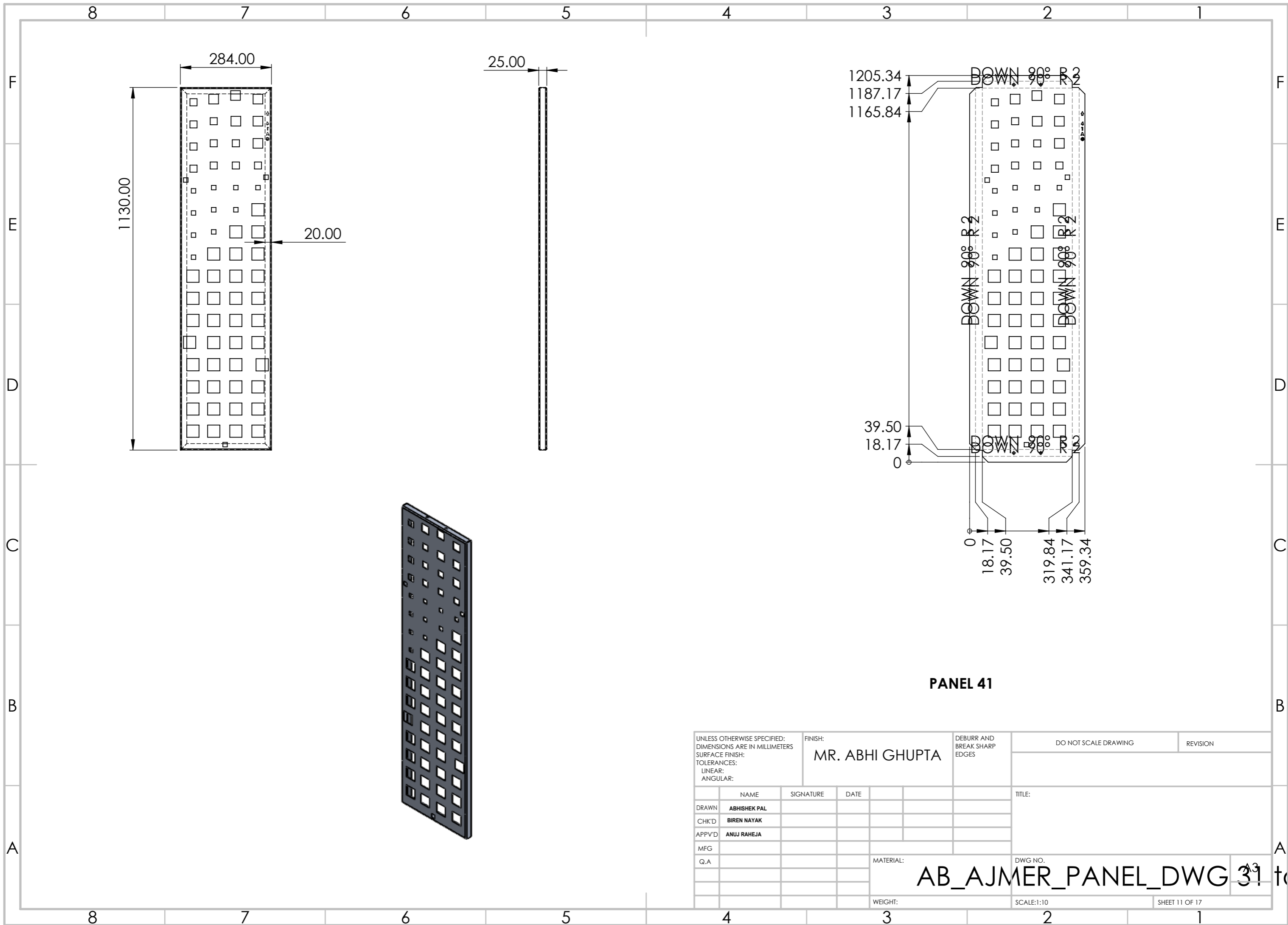

PANEL 41

UNLESS OTHERWISE SPECIFIED: DIMENSIONS ARE IN MILLIMETERS		FINISH: MR. ABHI GHUPTA		DEBURR AND BREAK SHARP EDGES		DO NOT SCALE DRAWING		REVISION	
SURFACE FINISH:									
TOLERANCES:									
LINEAR:									
ANGULAR:									
DRAWN: ABHISHEK PAL		SIGNATURE		DATE		TITLE:			
CHK'D: BIREN NAYAK									
APPV'D: ANUJ RAHEJA									
MFG									
Q.A						MATERIAL:		DWG NO.	
						WEIGHT:		SCALE:1:10	
								SHEET 11 OF 17	

AB_AJMER_PANEL_DWG 31 to 43

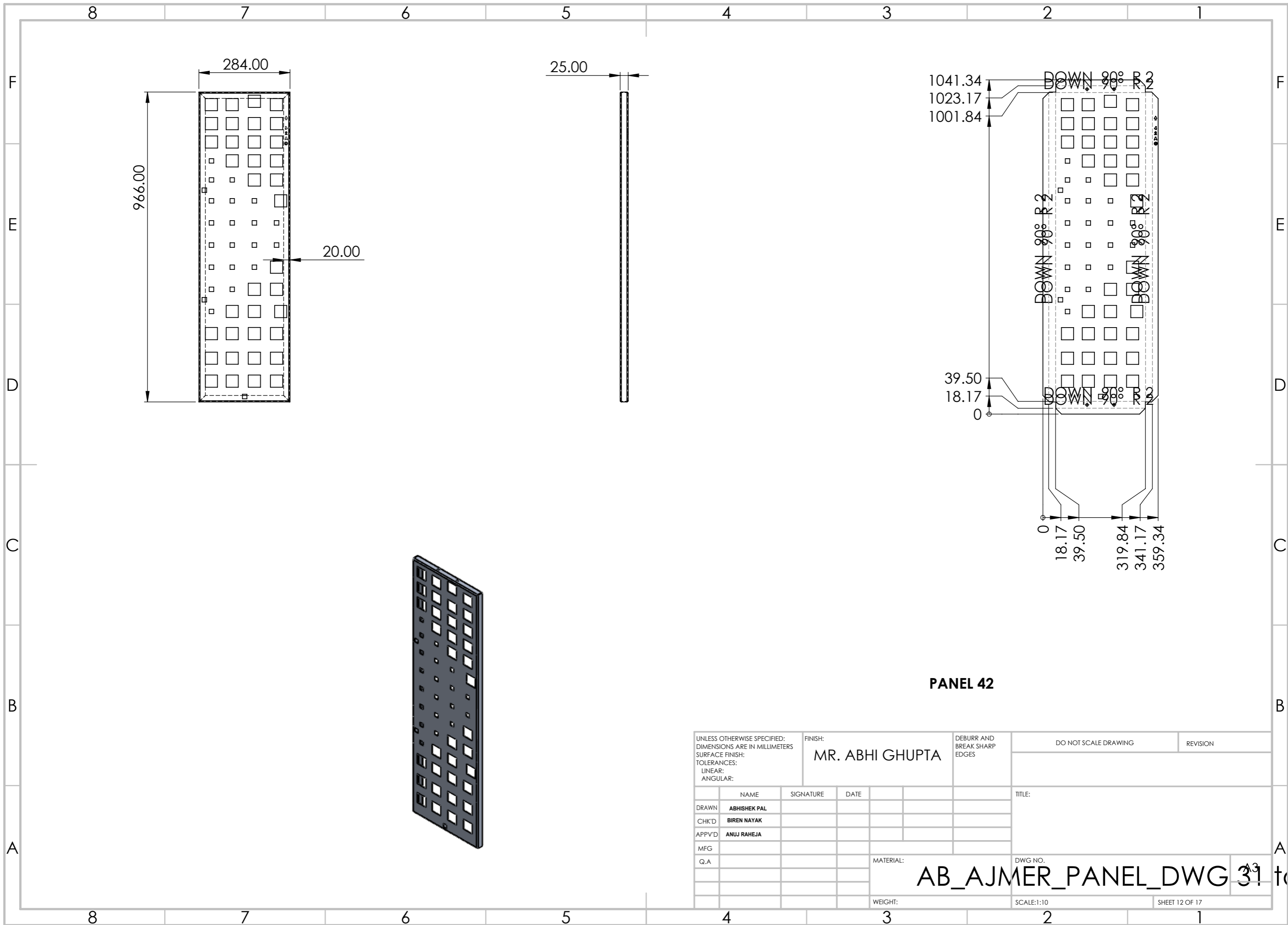

PANEL 42

UNLESS OTHERWISE SPECIFIED: DIMENSIONS ARE IN MILLIMETERS		FINISH: MR. ABHI GHUPTA		DEBURR AND BREAK SHARP EDGES		DO NOT SCALE DRAWING		REVISION	
SURFACE FINISH:									
TOLERANCES:									
LINEAR:									
ANGULAR:									
		NAME		SIGNATURE		DATE		TITLE:	
DRAWN		ABHISHEK PAL							
CHK'D		BIREN NAYAK							
APPV'D		ANUJ RAHEJA							
MFG									
Q.A									
				MATERIAL:		DWG NO.		31 to	
						AB_AJMER_PANEL_DWG			
				WEIGHT:		SCALE:1:10		SHEET 12 OF 17	

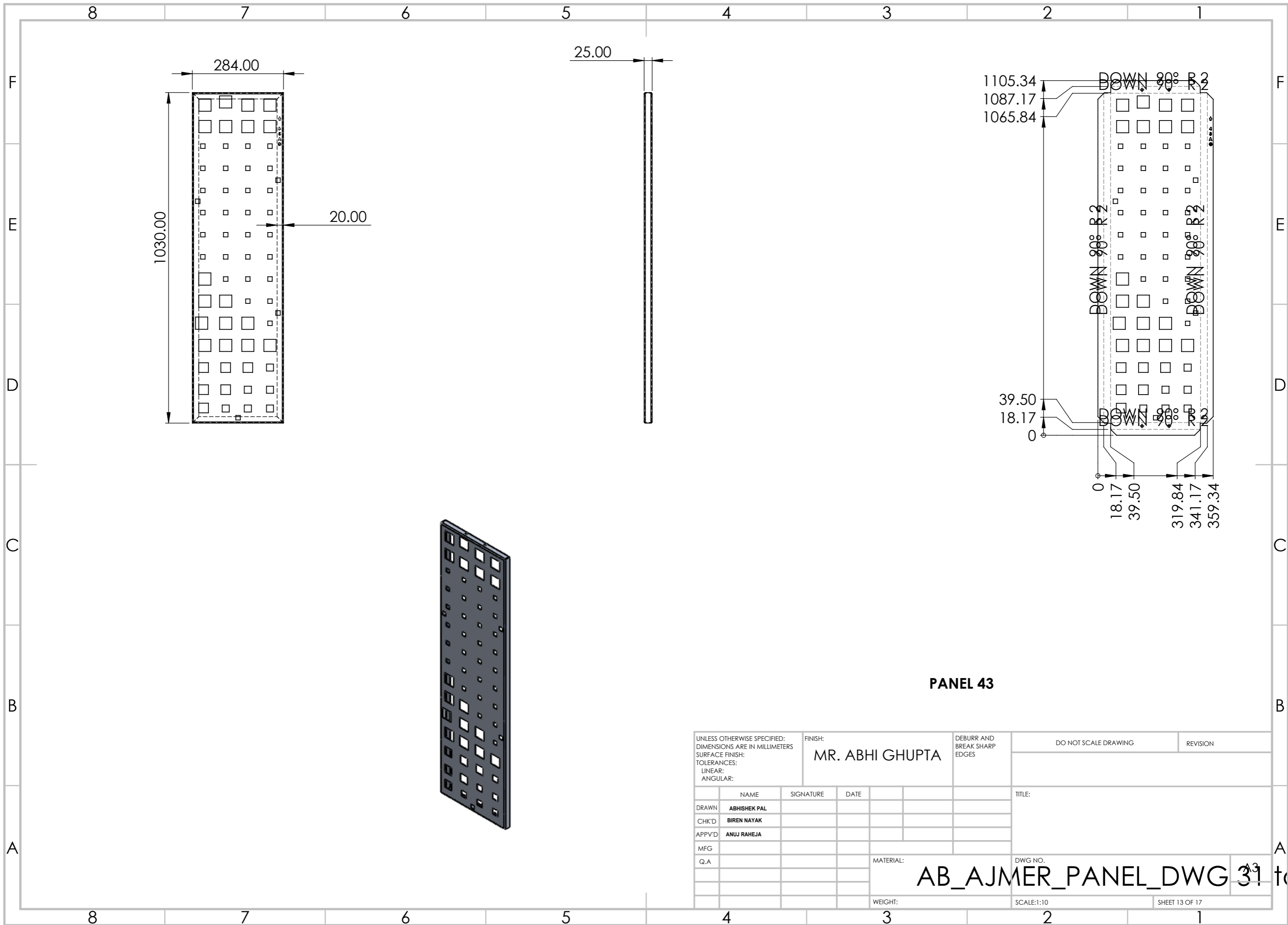

PANEL 43

UNLESS OTHERWISE SPECIFIED: DIMENSIONS ARE IN MILLIMETERS SURFACE FINISH: TOLERANCES: LINEAR: ANGULAR:		FINISH: MR. ABHI GHUPTA		DEBURR AND BREAK SHARP EDGES		DO NOT SCALE DRAWING		REVISION	
DRAWN ABHISHEK PAL		SIGNATURE		DATE		TITLE:			
CHK'D BIREN NAYAK									
APPV'D ANUJ RAHEJA									
MFG									
Q.A						MATERIAL:		DWG NO.	
						WEIGHT:		SCALE:1:10	
								SHEET 13 OF 17	

AB_AJMER_PANEL_DWG 31 to 43

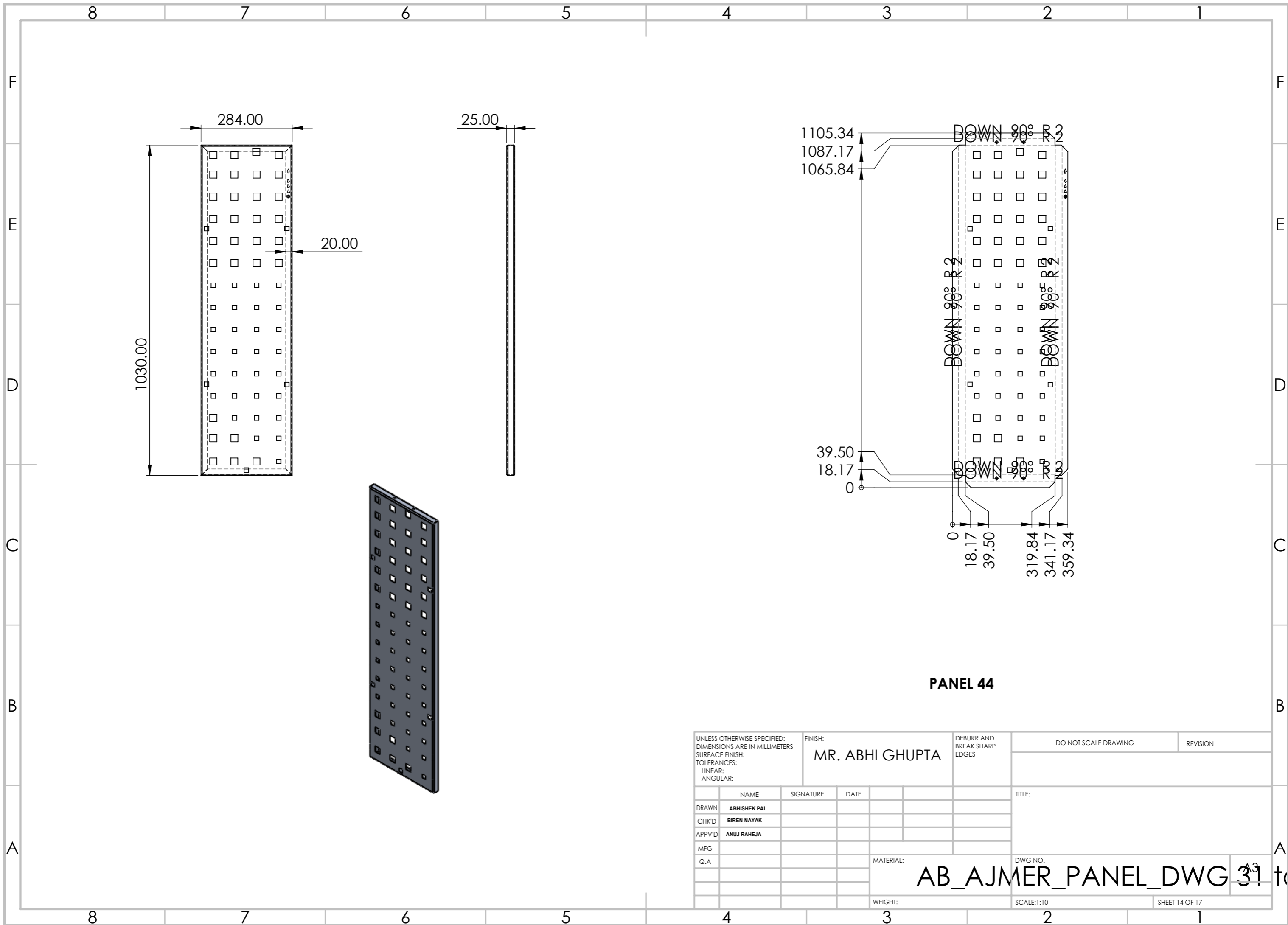

PANEL 44

UNLESS OTHERWISE SPECIFIED: DIMENSIONS ARE IN MILLIMETERS SURFACE FINISH: TOLERANCES: LINEAR: ANGULAR:		FINISH: MR. ABHI GHUPTA		DEBURR AND BREAK SHARP EDGES		DO NOT SCALE DRAWING		REVISION	
DRAWN ABHISHEK PAL		SIGNATURE		DATE		TITLE:			
CHK'D BIREN NAYAK									
APPV'D ANUJ RAHEJA									
MFG									
Q.A						MATERIAL:		DWG NO.	
						WEIGHT:		SCALE:1:10	
								SHEET 14 OF 17	

AB_AJMER_PANEL_DWG 31 to 43

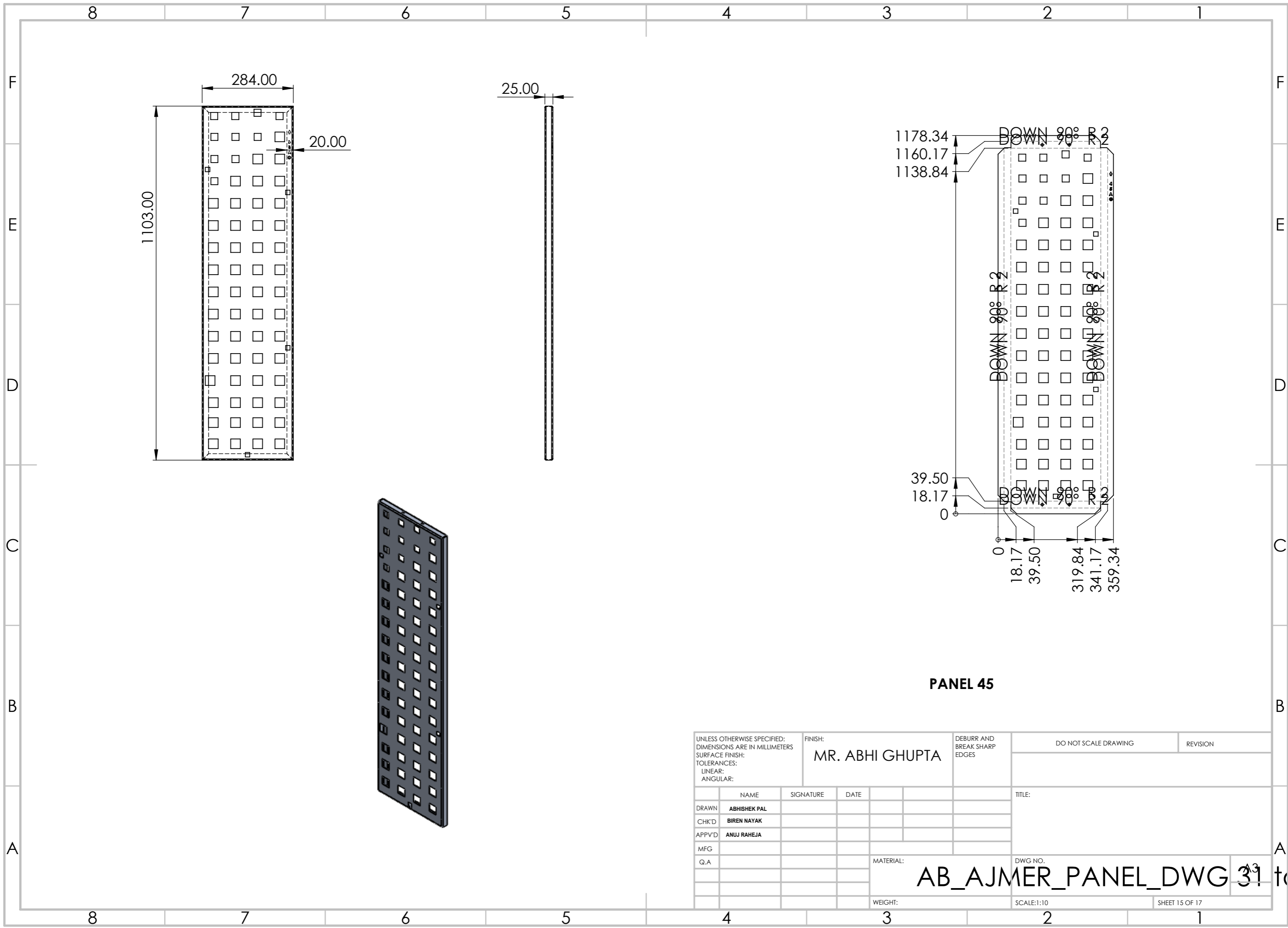

PANEL 45

UNLESS OTHERWISE SPECIFIED: DIMENSIONS ARE IN MILLIMETERS		FINISH: MR. ABHI GHUPTA		DEBURR AND BREAK SHARP EDGES		DO NOT SCALE DRAWING		REVISION	
SURFACE FINISH:									
TOLERANCES:									
LINEAR:									
ANGULAR:									
DRAWN: ABHISHEK PAL		SIGNATURE		DATE		TITLE:			
CHK'D: BIREN NAYAK									
APPV'D: ANUJ RAHEJA									
MFG									
Q.A						MATERIAL:		DWG NO.	
						AB_AJMER_PANEL_DWG		31 to 43	
						WEIGHT:		SCALE:1:10	
								SHEET 15 OF 17	

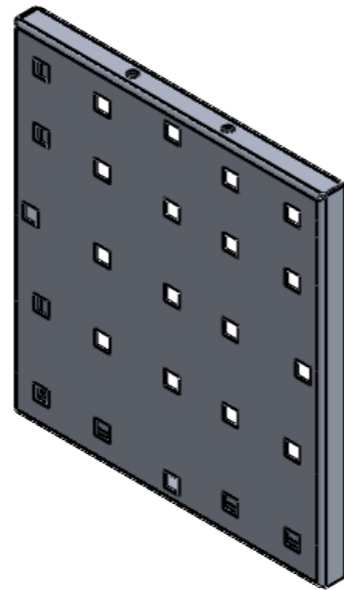
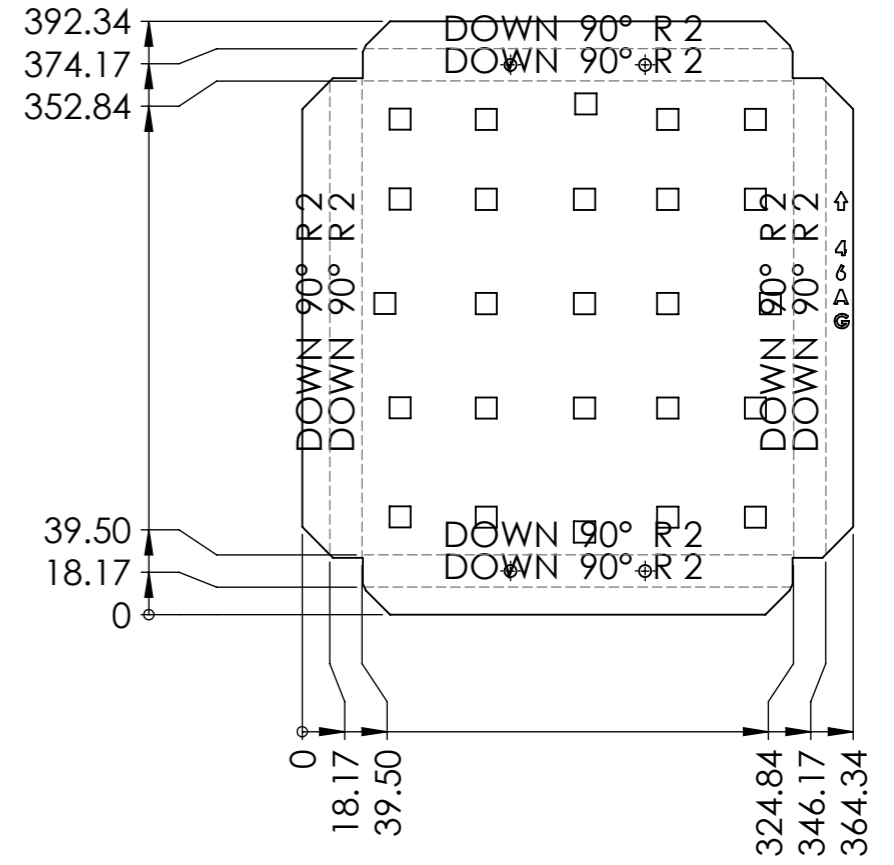
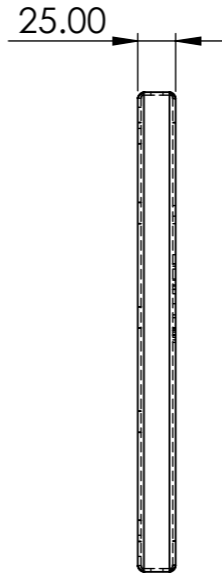
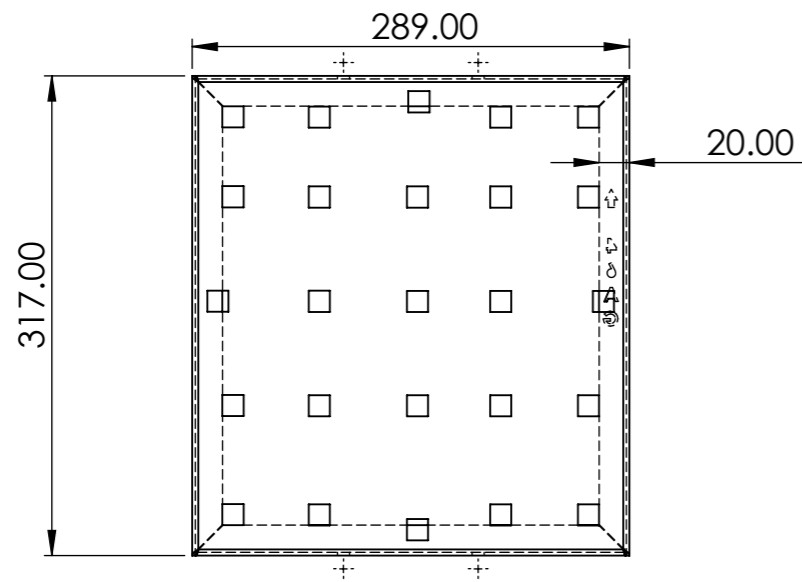

PANEL 46

UNLESS OTHERWISE SPECIFIED: DIMENSIONS ARE IN MILLIMETERS		FINISH: MR. ABHI GHUPTA		DEBURR AND BREAK SHARP EDGES		DO NOT SCALE DRAWING		REVISION	
SURFACE FINISH:									
TOLERANCES:									
LINEAR:									
ANGULAR:									
DRAWN ABHISHEK PAL		SIGNATURE		DATE		TITLE:			
CHK'D BIREN NAYAK									
APPV'D ANUJ RAHEJA									
MFG									
Q.A						MATERIAL:		DWG NO.	
								43	
						WEIGHT:		SCALE:1:5	
								SHEET 16 OF 17	

AB_AJMER_PANEL_DWG 31 to

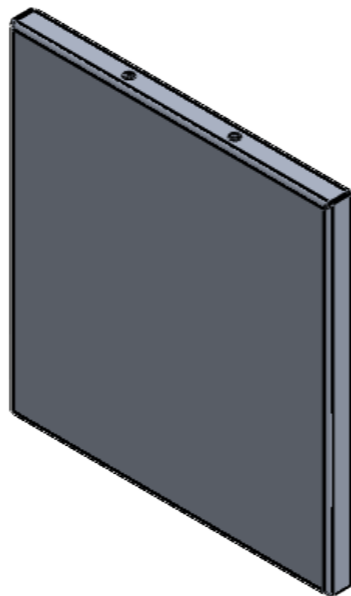
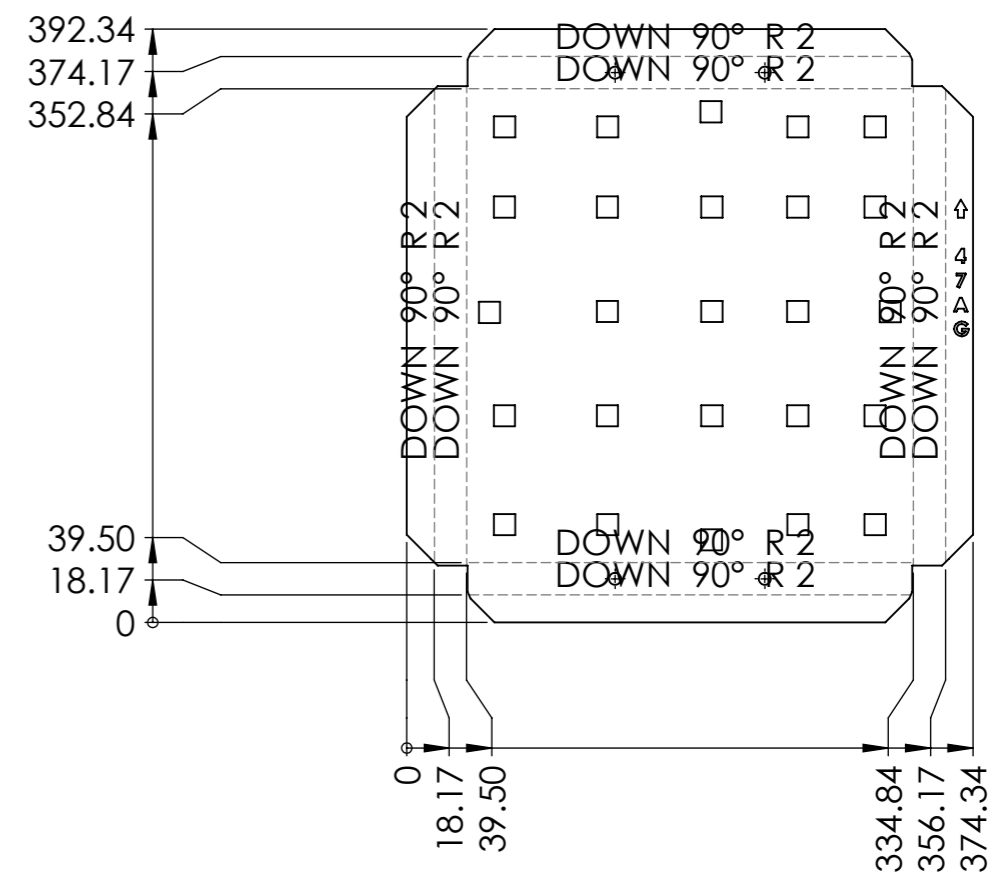
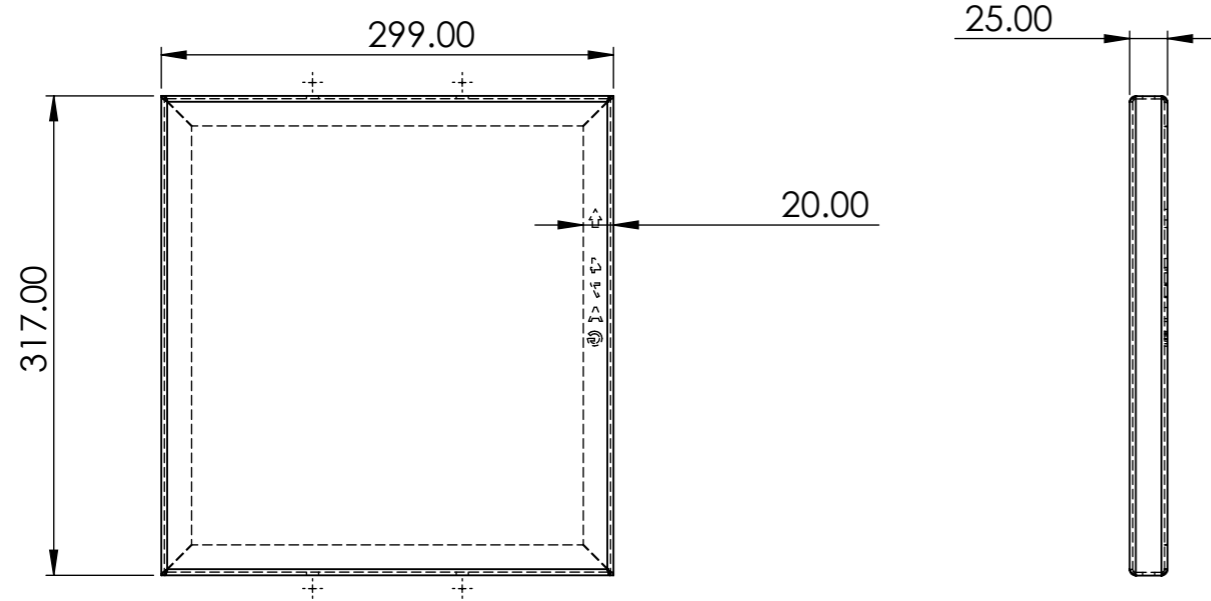

PANEL 47

UNLESS OTHERWISE SPECIFIED: DIMENSIONS ARE IN MILLIMETERS SURFACE FINISH: TOLERANCES: LINEAR: ANGULAR:		FINISH: MR. ABHI GHUPTA		DEBURR AND BREAK SHARP EDGES		DO NOT SCALE DRAWING		REVISION	
DRAWN ABHISHEK PAL		SIGNATURE		DATE		TITLE:			
CHK'D BIREN NAYAK									
APPV'D ANUJ RAHEJA									
MFG									
Q.A						MATERIAL:		DWG NO.	
						WEIGHT:		SCALE:1:5	
								SHEET 17 OF 17	

AB_AJMER_PANEL_DWG 31 to 43